

Accessories Catalog Heating solutions

For Cars, Trucks, Light-duty Vehicles, Special Vehicles, Rail and Recreational Vehicles



2016/2017

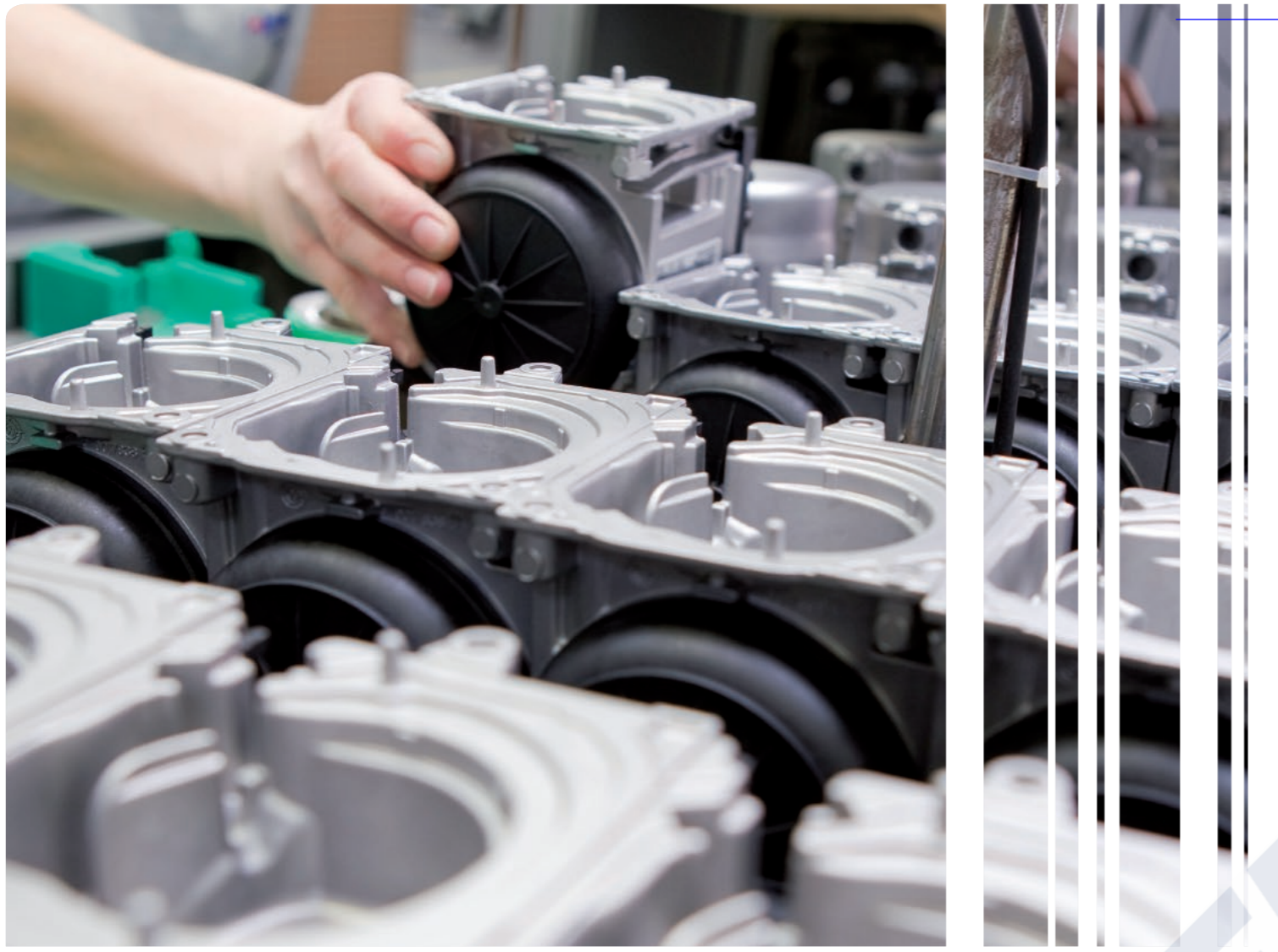

Table of Contents

Combustion Air System	8
Exhaust System	9
Fuel System	13
Hot Air System	19
Water System	26
Mounting Parts	32
Electrical Accessories	37
Test Equipment	43
Special Tools	44

Dear Customers, dear Webasto Partners,

this Webasto catalog will give you an overview of the complete range of accessories for our current heating systems. On the following pages, you will find everything that you need for installing our heating systems, according to the type of vehicle, location and use. The mounting parts, test equipment and tools shown here are clearly laid out to enable you to find and order what you need quickly.

Together with the second accessory catalog for air-conditioning solutions and the product catalogue (showing the basic scope of delivery, installation kits and control units), this catalog will provide a comprehensive source of information so that you can work efficiently with our heating and cooling units.

We wish you great success with our products,
Your Webasto Team

Combustion Air System

Exhaust System

Fuel System

Hot Air System

Water System

Mounting Parts

Electrical Accessories

Test Equipment

Special Tools

Application of an air heating system

Webasto air heating systems can be ordered in diverse scopes of delivery. The standard components are combined into a basic scopes of delivery and an installation kit. You may need additional application material, depending on the requirements for use and the installation location. You can find these in our extensive accessories program.

Our heating devices come with installation and operating instructions. For further information (e.g. spare parts lists), go to our dealer portal.

For information on our air heaters, see the separate product catalog entitled Heating and Air-Conditioning Solutions.

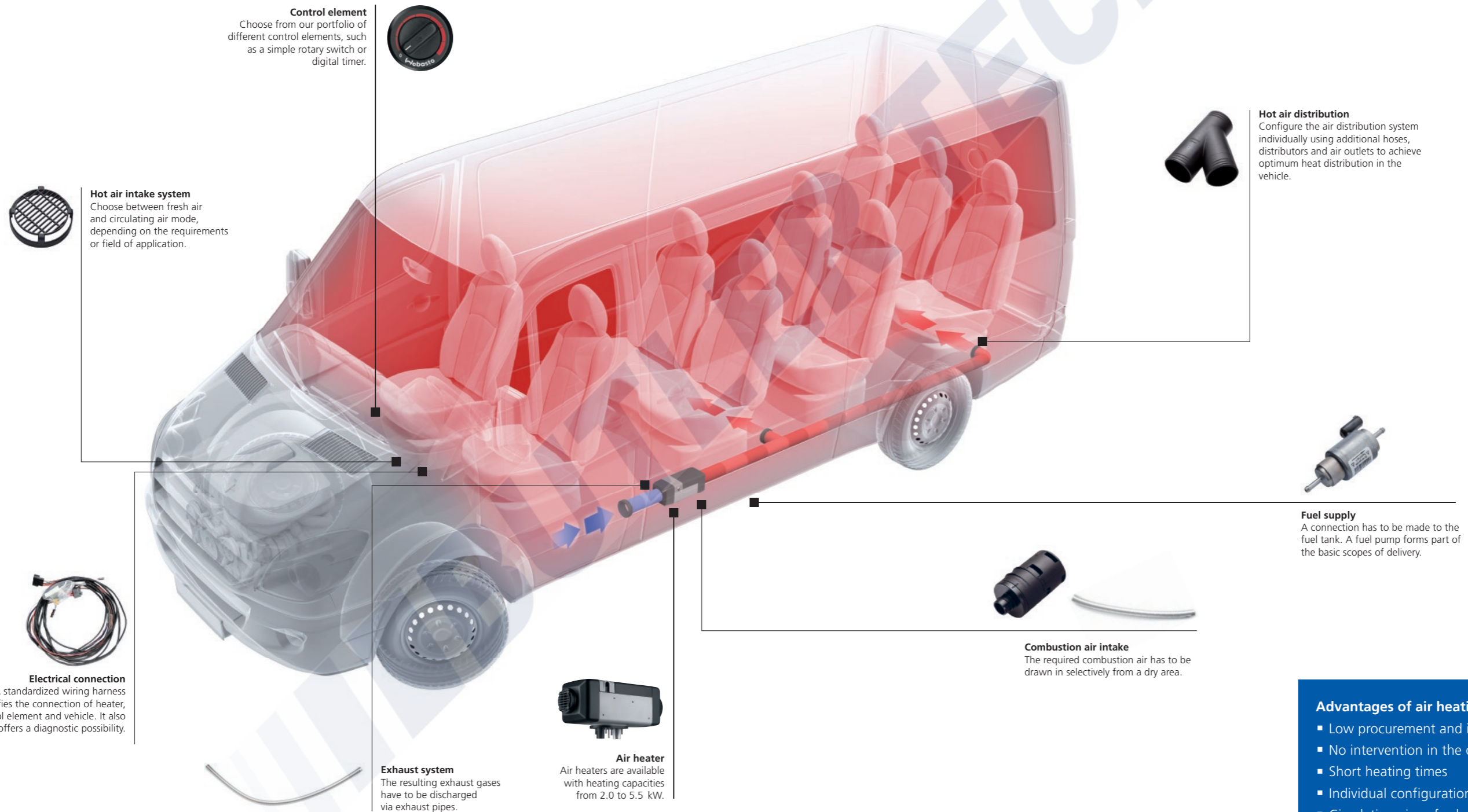

- Advantages of air heating systems**
- Low procurement and installation costs
 - No intervention in the original vehicle system
 - Short heating times
 - Individual configuration of the air distribution
 - Circulating air or fresh air mode

Application of a water heating system

Webasto water heating systems can be ordered in diverse scopes of delivery. The standard components are combined into a basic scopes of delivery and an installation kit. You may need additional application material, depending on the desired application and the installation location. You can find these in our extensive accessories program.

Our heating devices come with installation and operating instructions. For further information (e.g. spare parts lists) go to our dealer portal.

For information on our water heaters, see the separate product catalog entitled Heating and Air-Conditioning Solutions.

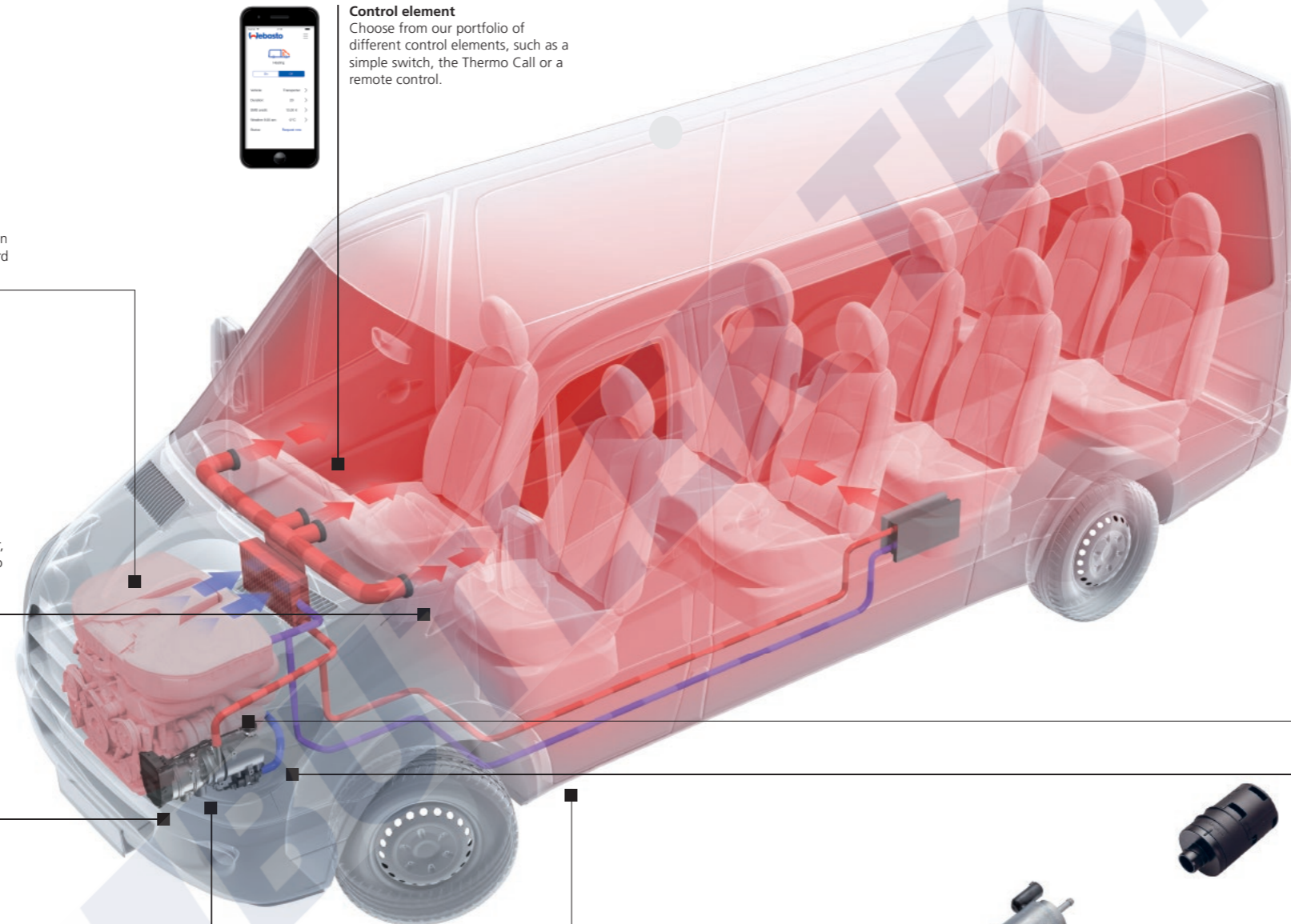

Integration into the water circuit
Depending on the vehicle type, choose the required application material such as hoses, valves or thermostats from the standard installation kit or our accessories portfolio.



Electrical connection
A standardized wiring harness simplifies the connection of heater, control element and vehicle. It also offers a diagnostic possibility.



Control element
Choose from our portfolio of different control elements, such as a simple switch, the Thermo Call or a remote control.



Coolant pump
Choose the required coolant pump from our range of accessories. For the Thermo Pro 50 Eco, Thermo Pro 90 and Thermo Top Evo heaters, a standard pump is included in the basic scopes of delivery.



Exhaust system
The resulting exhaust gases have to be discharged via exhaust pipes.



Combustion air intake
The required combustion air has to be drawn in selectively from a dry area.



Water heater
Heaters are available with heating capacities from 4 to 40 kW.



Fuel supply
A connection has to be made to the fuel tank. A fuel pump forms part of the basic scopes of delivery.

- Advantages of water heating systems**
- Engine preheating and/or cabin heating
 - Longer service life of the engine thanks to reduction in cold starts
 - Continued use of existing vehicle components
 - Use of the engine heat to bridge short standstill times without exhaust emissions

Combustion Air System

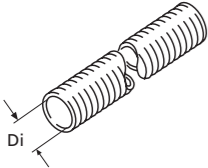
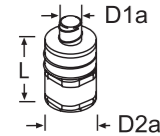
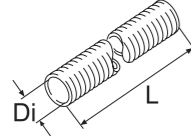
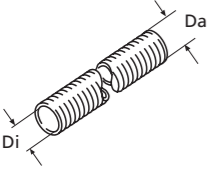
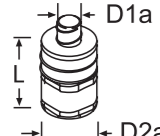
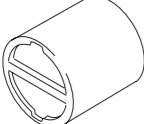
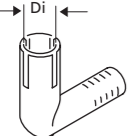
	Air Top 2000 STC	Air Top Evo 40/55	Thermo Top C/E	Thermo Pro 50 Eco	Thermo Top Evo	Thermo Pro 90	DBW 2010/2016	Thermo 230/300/350	Thermo S 230/300/350/400	Order number
	Flexible pipe									
				■	■					1319593A
	■									1321565A
	■									1321566A
		■								1321586A
		■								1321587A
	■									1321588A
						■				1321542A
						■				1321557A
						■				1321558A
						■				1321509A
						■				1321510A
	Intake muffler									
	■	■								98141A
	Intake muffler pipe									
	■									83174A
		■								1319924A
						■				1319607A
	Flexible exhaust pipe									
										1321494A
										1321495A
										1321496A
										1321493A
										Di = 30, Da = 34, stainless steel
	Air intake silencer									
		■								9025956A
	Protection cap									
	■									1320257A
		■								1321067A
						■				1320258A
										Plastic
	Combustion air elbow									
	■									1320144A
		■								1320278A
										Plastic

Exhaust System

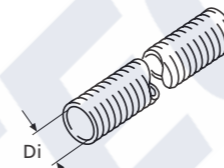
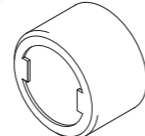
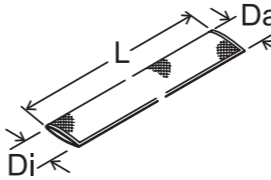
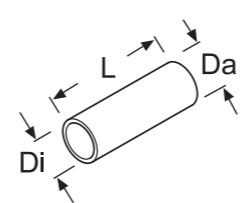
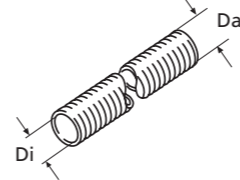
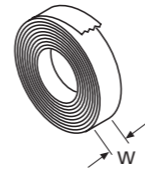
	Air Top 2000 STC	Air Top Evo 40/55	Thermo Top C/E	Thermo Pro 50 Eco	Thermo Top Evo	Thermo Pro 90	DBW 2010/2016	Thermo 230/300/350	Thermo S 230/300/350/400	Order number
	Flexible exhaust pipe, two-ply									
	■	■	■	■						1322414A
		■								1321523A
						■	■			1321540A
						■	■			1321541A
						■	■			1321539A
								■	■	1321568A
								■	■	1321567A
										Stainless steel
	Protection cap									
	■		■		■					1320109A
		■								1320217A
						■	■			1321753A
										Di = 42, 10 pieces
										L = 17, stainless steel, for flexible exhaust pipe
	Heat protection hose									
	■	■	■	■	■	■	■	■	■	1320830A
										L = 1,850
										Di = 70, Fiberglass
	Flexible heat protection pipe									
	■	■	■	■						1321601A
										Di = 28, Da = 32.5, GA-A (aluminium foil and aluminium coated glass fabric)
	■	■	■	■	■	■	■	■	■	1321602C
										Di = 45, Da = 48.5, GA2-A (aluminium and aluminium coated glass fabric)
										L = 10,000
	Flexible heat protection pipe									
	■	■	■	■						1319670A
										Di = 28, Da = 38, L = 324, with cover, non-flammable, interior resistant to temperatures up to 500 °C
	Insulating tape									
	■	■	■	■	■	■	■	■	■	1320357A
										L = 50,000, W = 60, E-glass, white, usage temperature 450 °C, 550 °C for short periods, 2 mm thick

Exhaust System

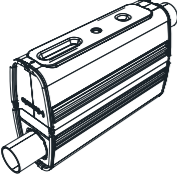
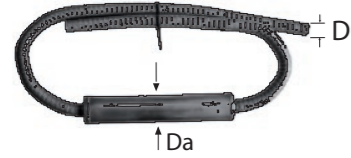
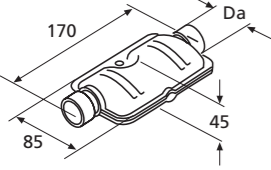
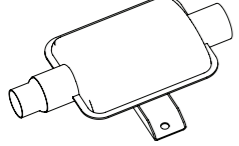
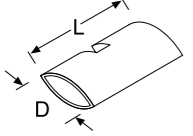
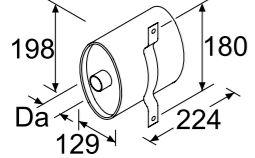
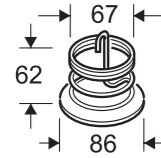
	Air Top 2000 STC	Air Top Evo 40/55	Thermo Top C/E	Thermo Pro 50 Eco	Thermo Top Evo	Thermo Pro 90	DBW 2010/2016	Thermo 230/300/350	Thermo S 230/300/350/400	Order number
 Exhaust muffler Da = 22, L = 179, W = 45, stainless steel	■	■	■	■						1320910A
 Exhaust muffler Di = 38, L = 1,000, outside with partial fiberglass insulation							■			1321823A
 Exhaust muffler Da = 22, steel, zinc powder paint surface protection for temperatures up to 650 °C Da = 22, stainless steel Da = 24, steel, zinc powder paint surface protection for temperatures up to 650 °C L = 170, W = 85, H = 45	■	■	■	■						1320841A 1320895A 1320372A
 Exhaust muffler Da = 38, L = 206, W = 57, steel, zinc powder paint surface protection for temperatures up to 600 °C							■	■		1320840A
 Insulating sleeve L = 120, W = 108, glass fabric, for exhaust mufflers 1320841A and 1320895A	■	■	■	■	■					1320848A
 Exhaust muffler Da = 38, L = 270, W = 130, stainless steel	■	■	■	■						1321397A
 Exhaust deflector							■	■		1320436A

Exhaust System

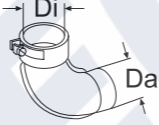
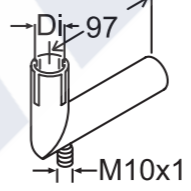
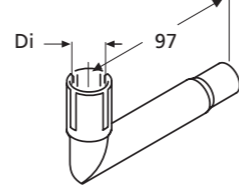
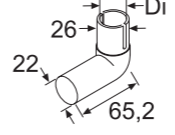
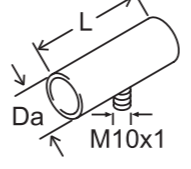
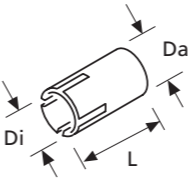
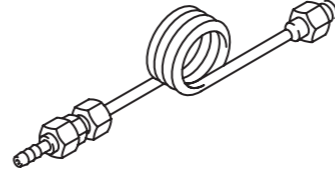
	Air Top 2000 STC	Air Top Evo 40/55	Thermo Top C/E	Thermo Pro 50 Eco	Thermo Top Evo	Thermo Pro 90	DBW 2010/2016	Thermo 230/300/350	Thermo S 230/300/350/400	Order number
 Hot air elbow Di = 71, Da = 67, L = 170, W = 85, 90°, painted								■	■	1319441A
 Exhaust elbow Di = 24, Da = 24, L = 110, stainless steel, with condensate drain		■								1320378A
 Exhaust elbow Di = 24, Da = 24, L = 110, stainless steel, without condensate drain		■								1320383A
 Exhaust elbow Di = 22, Da = 22, L = 65, aluminium, without condensate drain		■								1320117A
 Exhaust connecting pipe Da = 24, L = 50, M6, stainless steel, without condensate drain Da = 24, L = 65, steel, with anti-corrosion protection and condensate drain Da = 38, L = 65, stainless steel, for exhaust mufflers 1320841A and 1320895A, with condensate drain		■	■							1319937A 1319935A 1320959A
 Exhaust pipe reducer sleeve Di = 22, Da = 24, L = 40, stainless steel		■								1320382A
 Condensate drain L = 128, M10 x 1 connection thread, copper, for exhaust connecting pipe 1319935A, with mounting parts	■	■	■	■	■	■				92621A

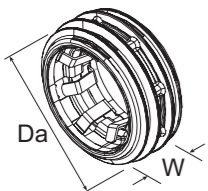
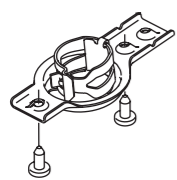

Exhaust System

	Air Top 2000 STC	Air Top Evo 40/55	Thermo Top C/E	Thermo Pro 50 Eco	Thermo Top Evo	Thermo Pro 90	DBW 2010/2016	Thermo 230/300/350	Thermo S 230/300/350/400	Order number
 <p>Spacer Di = 25, Da = 48, W = 21, for flexible pipe</p>	■	■	■	■						1317843A
 <p>End fixing kit for 24 mm flexible exhaust pipe, for fastening the exhaust end piece to the bottom of the vehicle</p>	■									1317567A

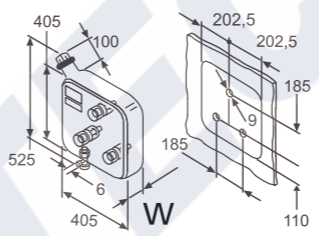
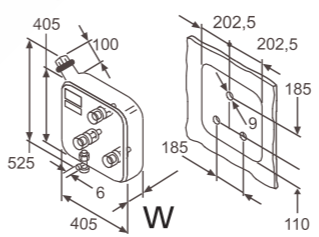
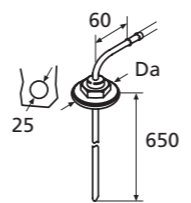
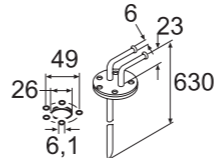
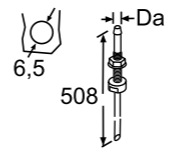
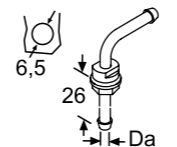

Fuel System

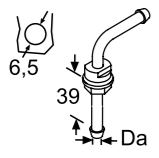
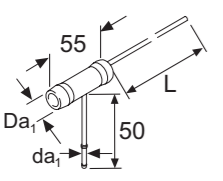
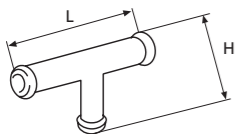
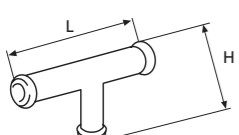
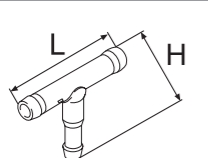
	Air Top 2000 STC	Air Top Evo 40/55	Thermo Top C/E	Thermo Pro 50 Eco	Thermo Top Evo	Thermo Pro 90	DBW 2010/2016	Thermo 230/300/350	Thermo S 230/300/350/400	Order number
 <p>Fuel tank L = 405, W = 94, plastic PE-LD, 12 liters</p>	■	■	■	■	■	■				1322707A
<p>Fuel tank installation kit Steel zinc coated, for 12-liter tank 9024224B</p>	■	■	■	■	■	■				9025761A
 <p>Fuel tank L = 405, W = 200, 24 l, plastic PE-LD, with assembly kit</p>	■	■	■	■	■	■				1322531A
 <p>Tank extracting device, riser pipe Di = 2.6, Da = 5, L = 650, steel zinc coated, 90° extractor connection piece, only for installation in metal tanks</p>	■	■	■	■	■	■				1320399A
 <p>Tank extracting device, riser pipe Da = 6, L = 630, galvanized steel, with return, 90° extractor connection piece, only for installation in metal tanks</p>							■	■	■	1322830B
 <p>Tank extracting device, riser pipe Di = 2.4, Da = 4.2, L = 440, thread M6, stainless steel, extractor connection piece, 39 mm long, vertical, for mounting in tank fitting, suitable for plastic tank and metal tank</p>	■	■	■	■	■	■				1300494D
 <p>Tank extracting device Di = 2.4, Da = 4.2, L = 26, M6 thread, steel zinc coated, extractor connection piece angled at 90°, for mounting in tank fitting, suitable for plastic tank and metal tank, short riser pipe</p>	■	■	■	■	■	■				1322827A

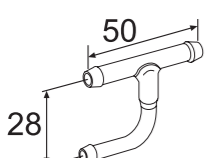
Fuel System

	Air Top 2000 STC	Air Top Evo 40/55	Thermo Top C/E	Thermo Pro 50 Eco	Thermo Top Evo	Thermo Pro 90	DBW 2010/2016	Thermo 230/300/350	Thermo S 230/300/350/400	Order number
 <p>Tank extracting device Di = 3, Da = 5, L = 39, steel zinc coated, with mounting parts for installation in tank fittings with length compensation</p>	■	■	■	■	■	■			9008021A	
 <p>Tank extracting device L = 50 L = 750 Di = 3, Da = 5, stainless steel, for fitting in tank ventilation line</p>	■	■	■	■	■	■			1320836A 1321824A	
 <p>Fuel extractor, T-piece H = 26, 6 x 5 x 6 H = 28, 8 x 5 x 8 L = 50, copper</p>	■	■	■	■	■	■			1319300A 1319301B	
 <p>Fuel extractor, T-piece H = 36, 6 x 5 x 6 H = 38, 8 x 5 x 8 H = 39, 10 x 5 x 10 H = 40, 12 x 5 x 12 L = 50, plastic</p>	■	■	■	■	■	■			1321002A 1320192A 1321003A 1319951A	
 <p>Fuel extractor, T-piece H = 33, 5 x 5 x 5 H = 36, 6 x 5 x 6 H = 35, 8 x 5 x 8 H = 37, 10 x 5 x 10 H = 37, 12 x 5 x 12 L = 50, steel zinc coated</p>	■	■	■	■	■	■			1321996A 1320572A 1320573A 1320804A 1320805A	
 <p>Fuel extractor, T-piece 15 x 6 x 15, steel zinc coated</p>	■	■	■	■	■	■			1320577A	
 <p>H-shaped fuel extractor H = 28, 6 x 5 x 6 H = 28, 8 x 5 x 8 H = 28, 10 x 5 x 10 H = 39, 12 x 5 x 12 L = 50, steel zinc coated, extraction at 90° elbow</p>	■	■	■	■	■	■			1319520A 1320574A 1320806A 1321776A	

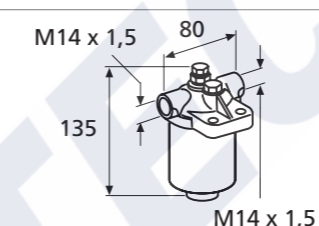
Fuel System

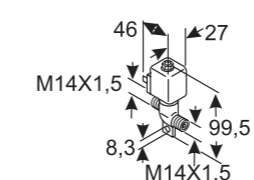
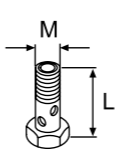
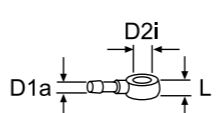
	Air Top 2000 STC	Air Top Evo 40/55	Thermo Top C/E	Thermo Pro 50 Eco	Thermo Top Evo	Thermo Pro 90	DBW 2010/2016	Thermo 230/300/350	Thermo S 230/300/350/400	Order number
 <p>Holder with housing for interchangeable filter L = 135, H = 80, M14 x 1.5 connection thread, light metal</p>							■	■	■	1319291A
 <p>Interchangeable filter For holder 1319291A</p>							■	■	■	1320031A
<p>Interchangeable RME filter For holder 1320017A</p>							■	■	■	1320018A
<p>KKC85/1 holder For interchangeable filters</p>							■	■	■	1319823A
<p>KKC84/1 holder with heater For interchangeable filters</p>							■	■	■	1320016A
<p>Interchangeable filter KC 74-089 For holders 1319823A and 1320016A</p>							■	■	■	1320015A
<p>Screw fittings kit Steel zinc coated, for soldered joints, Contents: double connection piece, union nuts, ring seals and sealing cone</p>							■	■	■	1320539A
 <p>Electric valve 24 V, M14 x 1.5 connection thread, for fuel line, Ambient temperature -40 °C to +80 °C, for 6.3 mm tab connectors</p>							■	■	■	1319443A
 <p>Banjo bolt L = 25, M10 x 1 thread, steel zinc coated, 2 pieces</p>							■	■	■	1320999A
 <p>Banjo D1a = 5, D2i = 10 D1a = 6, D2i = 12 D1a = 6, D2i = 10 L = 10, steel zinc coated</p>							■	■	■	1320747A 1319355A 1321062A

Fuel System

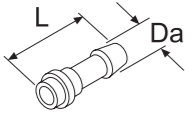
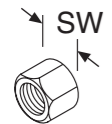
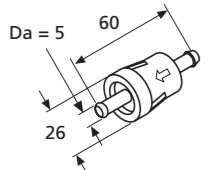
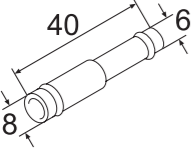
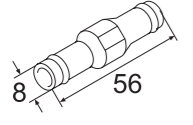
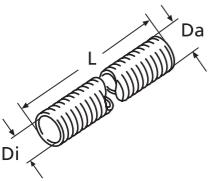
	Air Top 2000 STC	Air Top Evo 40/55	Thermo Top C/E	Thermo Pro 50 Eco	Thermo Top Evo	Thermo Pro 90	DBW 2010/2016	Thermo 230/300/350	Thermo S 230/300/350/400	Order number
	Hose sealing cone									
	Da = 5, L = 30									1319305A
	Da = 6, L = 30									1319702A
Da = 8, L = 32, 10 pieces									1320233A	
	Union nut									
	SW = 19, M14 x 1.5 thread, 10 pieces									1320243A
	Fuel filter kit									
	Da = 5, plastic transparent, with hose clips and connecting hoses									1318361A
	Reducer pipe									
	D = 8 – 6, brass									1319590A
	Connecting pipe									
	Da = 8, L = 56, plastic, VOME-resistant, 10 pieces									1321079A
	Flexible heat protection pipe									
	Di = 14.5, Da = 16.5, L = 5,000									1321585B
	Di = 14.5, Da = 16.5, L = 20,000									1321584B
	Di = 28, Da = 31, L = 2,000									1322650A
	Di = 28, Da = 31, L = 20,000									1317127A
GA-A (aluminium foil and aluminium coated glass fabric)										
Fuel line										
Di = 1.5, L = 1,500, black									9030545A	
Di = 1.5, L = 3,000, black									9030543A	
Di = 1.5, L = 6,000, black									9030542A	
Di = 1.5, L = 8,000, black									9030538A	
Di = 1.5, L = 11,000, black									9030540A	
Di = 1.5, L = 100,000, black									9030532A	
Di = 3, L = 12,000, blue, for Thermo Pro 90 at a pressure line length of 5 m, with white imprint									9028520A	
Da = 5, PA12 ETFE										

Fuel System

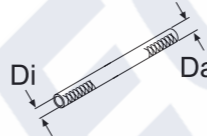
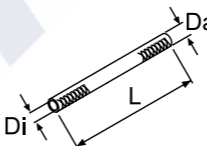
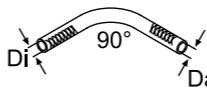
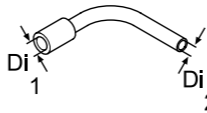
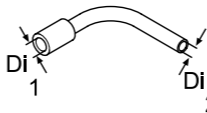
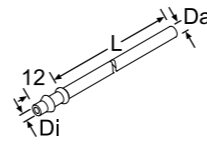
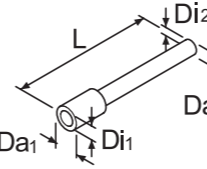
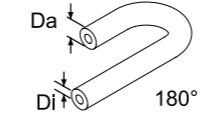
	Air Top 2000 STC	Air Top Evo 40/55	Thermo Top C/E	Thermo Pro 50 Eco	Thermo Top Evo	Thermo Pro 90	DBW 2010/2016	Thermo 230/300/350	Thermo S 230/300/350/400	Order number	
	Fuel hose										
	Di = 4.5, Da = 9, L = 5,000										1321500A
	Di = 4.5, Da = 9, L = 10,000										1321502A
	Di = 5, Da = 10, L = 5,000										1321559A
	Di = 5, Da = 10, L = 10,000										1321560A
	Di = 6, Da = 11, L = 5,000										1321563A
	Di = 6, Da = 11, L = 25,000										1321564A
	Fuel hose										
	L = 5,000, VOME-resistant										1321612B
	L = 10,000, VOME-resistant										1321613A
	L = 50, 20 pieces										9023450A
Di = 4.5, Da = 10.5											
	Molded fuel hose										
	90°										9023160A
	90°, VOME-resistant										9023384A
Di = 4.5, Da = 10.5, 10 pieces											
	Molded hose										
	Di1 = 7.5, Di2 = 4.5, 90°, with reduction										1319718A
	Molded fuel hose										
	Di1 = 4.5, Di2 = 3.5, 90°, RME-resistant, with reduction										1319677A
	Riser pipe										
	Di = 3, Da = 6, L = 322, plastic										1320413A
	Fuel hose										
	Di = 3.5, Da = 4.5, L = 50, RME-resistant, with reduction										1320862A
	Molded hose										
	Di = 4.5, Da = 10.5, 180°										1319686A



Fuel System

	Air Top 2000 STC	Air Top Evo 40/55	Thermo Top C/E	Thermo Pro 50 Eco	Thermo Top Evo	Thermo Pro 90	DBW 2010/2016	Thermo 230/300/350	Thermo S 230/300/350/400	Order number
 <p>Fuel hose kit Di = 4.5, Da = 10, L = 50, VOME-resistant, 5 x hoses, 10 x hose clips</p>	■	■	■	■	■	■				1322837A
 <p>Fuel pump hanger kit For dosing pump DP2 and DP30, also for fastening to stud bolts belonging to the vehicle</p>	■	■	■	■	■	■				92296A
 <p>Fuel pump holder Solid rubber, very quiet mounting, bag of 3 pieces</p>	■	■	■	■	■	■				9023386A
 <p>Support sleeve Da = 6, L = 15, brass, 10 pieces Da = 7, L = 36 Da = 8, L = 15 For reinforcing plastic pipes</p>	■	■	■	■	■	■	■	■	■	1321071A 1320164A 1320198A
 <p>Mini Jacket fuel pump protector Protection device for fuel pumps with mufflers, required by ISO 7840 if the fuel system is installed in engine rooms</p>	■	■	■	■	■	■				1319522A
 <p>Metal fuel line kit for boats Di = 1.5, Da = 5, L = 5,000, EN ISO 7840 with screw fasteners, hoses and clips</p>	■	■	■	■	■	■				66958B
 <p>Fuel hose for boats Di = 5, Da = 15, L = 50</p>	■	■	■	■	■	■				1320857A
 <p>Fuel line for boats Di = 1.5, Da = 5, L = 5,000, stainless steel</p>	■	■	■	■	■	■				1320860A

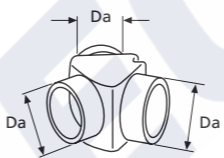
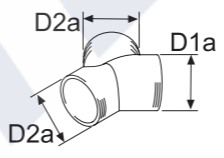
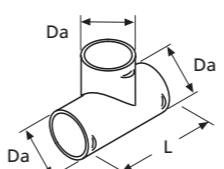
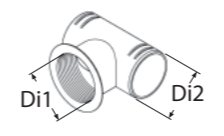
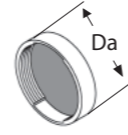
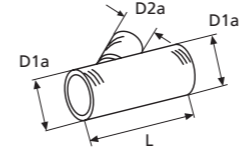
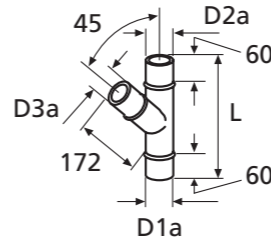
Hot Air System

	Air Top 2000 STC	Air Top Evo 40/55	Thermo Top C/E	Thermo Pro 50 Eco	Thermo Top Evo	Thermo Pro 90	DBW 2010/2016	Thermo 230/300/350	Thermo S 230/300/350/400	Dual Top Evo	Order number
 <p>Distributor Y-unit Da = 55 Da = 80 Plastic, black</p>	■	■								■	1319416A 1319212A
 <p>Distributor Y-unit D1a = 80, D2a = 55, to be used in the secondary flow only D1a = 60, D2a = 60 D1a = 90, D2a = 80 D1a = 90, D2a = 90 D1a = 80, D2a = 60 Plastic, black</p>		■								■	1320753A 1320814A 1320375A 1320470A 1320471A
 <p>T-unit Da = 60 Da = 90 L = 110, 90°, plastic, black</p>	■	■								■	1320474A 1320473A
 <p>T-unit Di1 = 90, Di2 = 60, 90°, plastic, black, with thread</p>	■	■								■	1320476A
 <p>End Cap Da = 60 Da = 90 Plastic, black</p>	■	■								■	1320477A 1319870A
 <p>Junction fitting D1a = 60, L = 145 D1a = 90, L = 146 D2a = 60, 45°, plastic, black</p>	■	■								■	1320472A 1320707A
 <p>Junction fitting D1a = 80, D2a = 80, D3a = 80, L = 370, 45°, steel corrosion-resistant</p>		■								■	1319315A

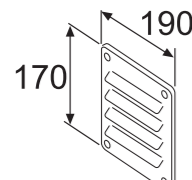

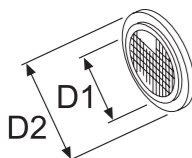
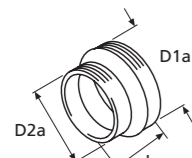
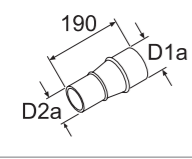
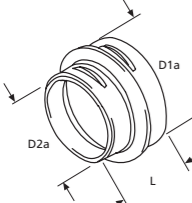

Hot Air System

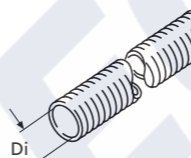
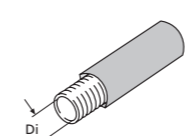
	Air Top 2000 5TC	Air Top Evo 40/55	Thermo Top C/E	Thermo Pro 50 Eco	Thermo Top Evo	Thermo Pro 90	DBW 2010/2016	Thermo 230/300/350	Thermo S 230/300/350/400	Dual Top Evo	Order number
 <p>Louvre plate L = 190, H = 170, aluminium</p>	■	■								■	1319269A
 <p>Screen Di = 60, plastic, black, for intake and outlet openings of heater</p>	■										1320163A
 <p>Protective screen Di = 60, rubber, for heater intake</p>	■										1320173A
 <p>Screen (anti-ingress) Di = 80, Da = 112, steel chromed</p>	■										1319308A
 <p>Reducer for air hose D1a = 60, D2a = 55, L = 35 D1a = 90, D2a = 80, L = 45 D1a = 80, D2a = 55, L = 82 Plastic, black, for flexible pipe</p>	■		■							■	1320127A 1320185A 1319477A
 <p>Reducer pipe D1a = 80, D2a = 60, L = 190, steel corrosion-resistant, for flexible pipe</p>	■										1319312A
 <p>Adapter for heater connection D1a = 75, D2a = 60 D1a = 90, D2a = 80 L = 40, plastic, black</p>	■		■							■	1321005A 1320186A

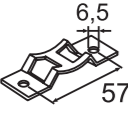
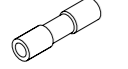

Hot Air System

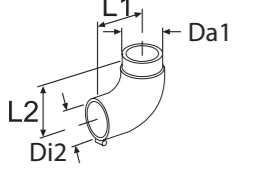
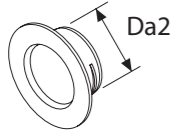
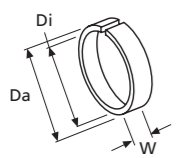
	Air Top 2000 5TC	Air Top Evo 40/55	Thermo Top C/E	Thermo Pro 50 Eco	Thermo Top Evo	Thermo Pro 90	DBW 2010/2016	Thermo 230/300/350	Thermo S 230/300/350/400	Dual Top Evo	Order number
 <p>Flexible pipe Di = 55, L = 2,000 APK, black Di = 55, L = 5,000 APK, black Di = 55, L = 10,000 APK, black Di = 55, L = 25,000 APK, black Di = 60, L = 25,000 APK, black Di = 60, L = 10,000 APK, black Di = 60, L = 2,000 APK, black Di = 60, L = 5,000 APK, black Di = 80, L = 25,000 APK, black Di = 80, L = 10,000 APK, black Di = 80, L = 2,000 APK, black Di = 80, L = 5,000 APK, black Di = 90, L = 25,000 APK, black Di = 90, L = 10,000 APK, black Di = 90, L = 2,000 APK, black Di = 90, L = 5,000 APK, black Di = 60, L = 3,000 PAKH Di = 55, L = 25,000 PAKP, grey Di = 55, L = 10,000 PAKP, grey Di = 55, L = 2,000 PAKP, grey Di = 55, L = 5,000 PAKP, grey Di = 55, L = 10,000, PAK Di = 55, L = 20,000, PAK Di = 60, L = 25,000, PAKP, grey Di = 60, L = 10,000, PAKP, grey Di = 60, L = 2,000, PAKP, grey Di = 60, L = 5,000, PAKP, grey Di = 80, L = 25,000, PAKP, grey Di = 80, L = 10,000, PAKP, grey Di = 80, L = 2,000, PAKP, grey Di = 80, L = 5,000, PAKP, grey Di = 80, L = 10,000, PAK Di = 90, L = 25,000, PAKP, grey Di = 90, L = 10,000, PAKP, grey Di = 90, L = 2,000, PAKP, grey Di = 90, L = 5,000, PAKP, grey Di = 55, L = 20,000, AA Di = 80, L = 1,000, AA Di = 80, L = 5,000, AA Di = 80, L = 10,000, AA</p>	■	■								■	1315889A 1321573B 1322082A 1311891C 1311892C 1322083C 1321574B 1321575C 1311893C 1321718C 1321576C 1321577B 1311894C 1321719C 1321578C 1321579C 1321511A 1311896C 1321722B 1321580B 1321581B 1321701B 1321703B 1311898C 1321727C 1321504A 1321505A 1311900C 1321729B 1321582B 1321583B 1322147B 1311902C 1321731C 1321506B 1321508B 1321503A 1321531A 1321532A 1321533A
 <p>Insulated hoses Di = 80 Di = 90 PAK L = 12,000 mm</p>		■								■	1321515A 1321517A

Hot Air System

	Air Top 2000 5TC	Air Top Evo 40/55	Thermo Top C/E	Thermo Pro 50 Eco	Thermo Top Evo	Thermo Pro 90	DBW 2010/2016	Thermo 230/300/350	Thermo S 230/300/350/400	Dual Top Evo	Order number
	Console										
For mounting flexible pipes with corresponding hose clip	■	■								■	1321044A
	Double fitting										
Da = 60, L = 50	■	■								■	1320469A
Da = 80, L = 75		■								■	1319476A
Da = 90, L = 50		■								■	1319869A
Plastic, black, for connecting flexible pipes											
	Reduction adapter										
Da = 80		■								■	1320925A
Da = 60		■								■	1320760A
Di = 90, plastic, black, for connecting flexible pipes											
	Elbow										
Da = 90, 90°, plastic, black		■								■	1320706A
	Elbow										
Di2 = 80.5, Da1 = 79, L1 = 115, L2 = 120		■								■	1319272A
Di2 = 102.5, Da1 = 99, L1 = 142, L2 = 142		■								■	1319273A
90°, steel corrosion-resistant											
	Wall feed-through										
Da = 60	■	■								■	1320923A
Da = 90		■								■	1320924A
Plastic, black											
	Adaptor ring										
Di = 55, Da = 60	■	■								■	1320224A
Di = 70, Da = 80, for outlet 1319946A		■								■	1320040A
W = 17, plastic, black											
	Air Outlet										
Da = 60, black	■	■								■	1320206A
Da = 60, white	■	■								■	1320207A
Da = 60, grey	■	■								■	1320937A
Da = 90, black		■								■	1320355A
Da = 90, white		■								■	1320713A
Da = 90, grey		■								■	1320714A
Plastic, lockable, bag with wall feed through											

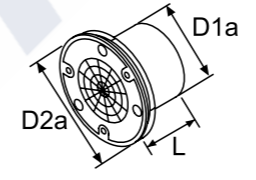
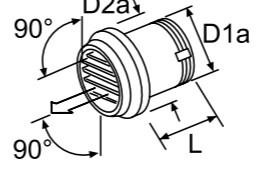
Hot Air System

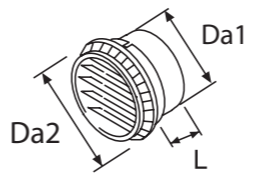
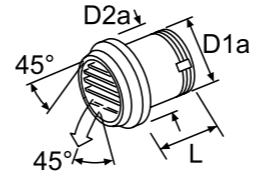
	Air Top 2000 5TC	Air Top Evo 40/55	Thermo Top C/E	Thermo Pro 50 Eco	Thermo Top Evo	Thermo Pro 90	DBW 2010/2016	Thermo 230/300/350	Thermo S 230/300/350/400	Dual Top Evo	Order number
	Air Outlet										
Da = 60, black	■	■								■	1320934A
Da = 60, white	■	■								■	1320935A
Da = 60, grey	■	■								■	1320936A
Da = 90, black		■								■	1320932A
Da = 90, white		■								■	1320712A
Da = 90, grey		■								■	1320711A
Plastic, axiale Durchströmung, bag with wall feed through											
	Outlet										
D1a = 60, D2a = 92, L = 65, plastic, black, axial flow, with bushing	■	■								■	1322634A
	Air Outlet										
D1a = 55, D2a = 87	■	■								■	101625
D1a = 80, D2a = 110		■								■	1322710A
L = 65, 90°, plastic, black, insert grid, straight, rotating											
	Air outlet										
Da = 60, black	■	■								■	1320204A
Da = 60, white	■	■								■	1320205A
Da = 60, grey	■	■								■	1320933A
Da = 60, brown	■	■								■	1320761A
Da = 90, black		■								■	1320709A
Da = 90, white		■								■	1320710A
Da = 90, grey		■								■	1320354A
45°, plastic, through flow with bushing											
	Air outlet										
D1a = 90, D2a = 120, L = 65, 45°, plastic, black, through flow with bushing		■								■	1320956A
	Air outlet										
D1a = 55, D2a = 87	■	■								■	107836
D1a = 80, D2a = 110		■								■	107984
L = 65, 45°, plastic, black, through flow, rotatable, with bushing											

Hot Air System

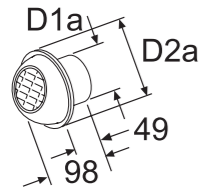
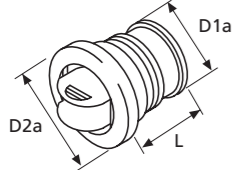
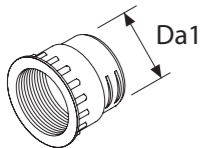
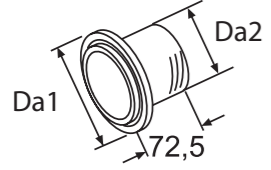
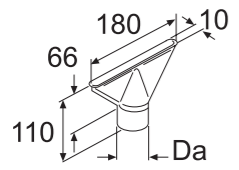
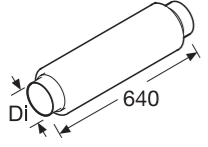
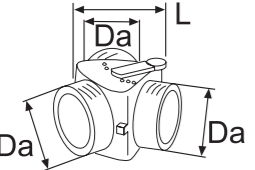
	Air Top 2000 5TC	Air Top Evo 40/55	Thermo Top C/E	Thermo Pro 50 Eco	Thermo Top Evo	Thermo Pro 90	DBW 2010/2016	Thermo 230/300/350	Thermo S 230/300/350/400	Dual Top Evo	Order number	
	Air outlet											
	D1a = 60, D2a = 92											1322405A
	D1a = 80, D2a = 120											1319327A
Plastic, black, rotatable, with bushing, with ball-type cover												
	Air outlet											
	D1a = 55											1320812A
	D1a = 70, use for secondary flow only											1319946A
D2a = 100, L = 65, plastic, black, closable, with bushing												
	Union nut for outlet											
	Da = 60											1320922A
	Da = 90											1320468A
L = 60, plastic, black												
	Wall pipe											
	D1a = 87, D2a = 55											1320063A
	D1a = 110, D2a = 80											1319471A
L = 73, plastic, black												
	Demist nozzle											
	Da = 55, steel corrosion-resistant											1319470A
	Air ducting silencer											
	Di = 90, L = 600, aluminium/plastic											1321734A
	Distributor											
	Da = 55, L = 95											1319224A
	Da = 80, L = 124											1319214A
Plastic, black, with remote control flap valve												

Hot Air System

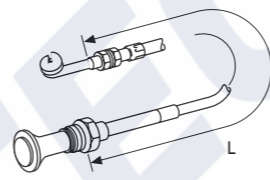
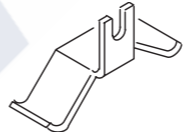
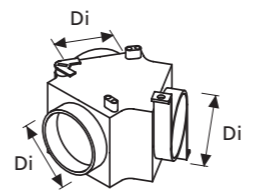
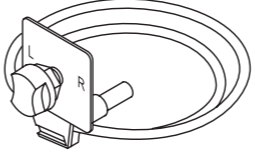
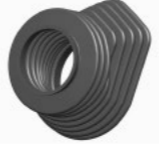
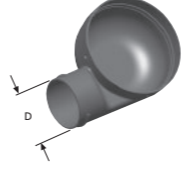
	Air Top 2000 5TC	Air Top Evo 40/55	Thermo Top C/E	Thermo Pro 50 Eco	Thermo Top Evo	Thermo Pro 90	DBW 2010/2016	Thermo 230/300/350	Thermo S 230/300/350/400	Dual Top Evo	Order number	
	Control cable											
	L = 850											1320785A
	L = 1,500											1320786A
For Distributor 1319224A and 1319214A, with grip and outer sleeve												
	Clamp											
	For Bowden Cable 1320785A and 1320786A											1319688A
	Distributor											
	Di = 60											1320352A
	Di = 90											1320926A
Plastic, black, with control butterfly valve												
	Control device for distributor											
	L = 2,000, for Distributor 1320352A and 1320926A, with control butterfly valve											1319868A
	Rubber bellow											
												9018647C
	Dual Top air intake cover											
	D = 60											1314904A

Water System

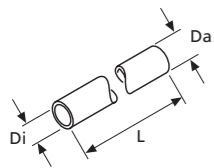
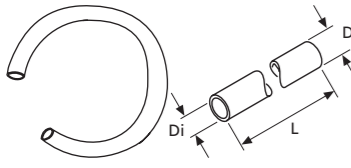
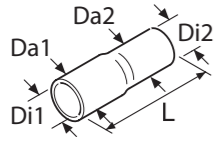
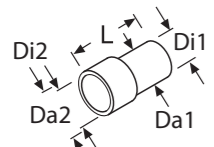
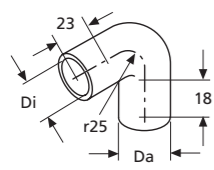
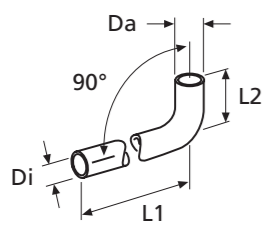
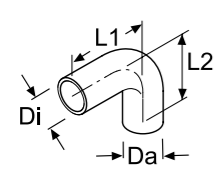
	Air Top 2000 STC	Air Top Evo 40/55	Thermo Top C/E	Thermo Pro 50 Eco	Thermo Top Evo	Thermo Pro 90	DBW 2010/2016	Thermo 230/300/350	Thermo S 230/300/350/400	Order number
			■	■	■	■	■	■	■	1320300A
Hose Di = 15, Da = 22, L = 2,400										
					■					1322423A
Hose Di = 18, Da = 25, L = 2,000, PER-EPDM										
			■	■	■	■	■	■	■	1320856A
Reducing hose D1i = 20, D1a = 27, D2i = 18, D2a = 25, L = 60										
								■	■	1320374A
Reducing hose D1i = 28, D1a = 37, D2i = 38, D2a = 47, L = 100, silicone										
			■	■	■	■	■	■	■	1319418A
Molded hose Di = 18, Da = 25, 90°										
			■	■	■	■	■	■	■	1320789A
Molded hose Di = 15, Da = 22, L1 = 1,020, L2 = 50			■	■	■	■	■	■	■	1320907A
Di = 18, Da = 25, L1 = 125, L2 = 90			■	■	■	■	■	■	■	1319953A
Di = 18, Da = 25, L1 = 500, L2 = 48			■	■	■	■	■	■	■	1320794A
Di = 18, Da = 27, L1 = 1,020, L2 = 50			■	■	■	■	■	■	■	1319839A
Di = 20, Da = 27, L1 = 70, L2 = 57			■	■	■	■	■	■	■	1320147A
Di = 20, Da = 27, L1 = 130, L2 = 57										
90°										
							■	■	■	1319934A
Molded hose L1 = 70, L2 = 105, Di = 38, Da = 47, 90°, silicone										

Water System

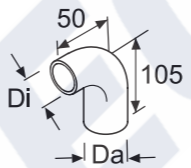
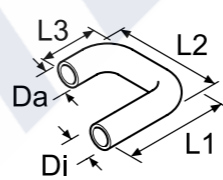
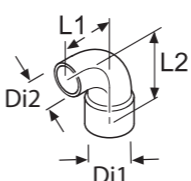
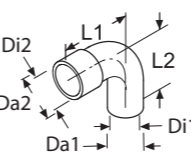
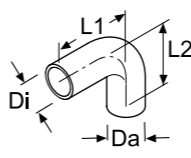
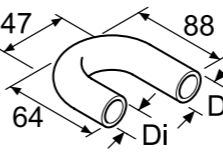
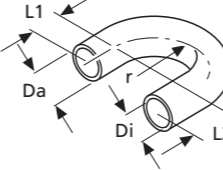
	Air Top 2000 STC	Air Top Evo 40/55	Thermo Top C/E	Thermo Pro 50 Eco	Thermo Top Evo	Thermo Pro 90	DBW 2010/2016	Thermo 230/300/350	Thermo S 230/300/350/400	Order number
			■	■	■	■	■	■	■	1319717A
Molded hose Di = 15, Da = 25, 90°, silicone										
			■	■	■	■	■	■	■	1320988A
Molded hose Di = 20, Da = 27, L1 = 190, L2 = 120, L3 = 70, 180°										
								■	■	1319827A
Molded hose Da = 47, D1i = 38, D2i = 32, L1 = 90, L2 = 70, 90°, silicone, with reduction										
								■	■	1319679A
Molded hose D1i = 35, D1a = 44, D2i = 38, D2a = 47, L1 = 80, L2 = 80, 90°, silicone, with reduction										
			■	■	■	■	■	■	■	1319673A
Molded hose Di = 20, Da = 27, L1 = 59, L2 = 54, 90°, with reduction										
			■	■	■	■	■	■	■	1320913A
Molded hose Di = 20, Da = 27, L1 = 64, L2 = 88, W = 47, 180°										
			■	■	■	■	■	■	■	1319401A
Molded hose Di = 18, Da = 25, r = 25, L1 = 18, L2 = 18			■	■	■	■	■	■	■	1319623A
Di = 20, Da = 27, r = 23.5, L1 = 88, L2 = 64										
180°										

Water System

		Air Top 2000 STC	Air Top Evo 40/55	Thermo Top C/E	Thermo Pro 50 Eco	Thermo Top Evo	Thermo Pro 90	DBW 2010/2016	Thermo 230/300/350	Thermo S 230/300/350/400	Order number
	Molded hose										
	Di = 15, L1 = 580, L2 = 17, H = 75			■	■			■			1320790A
	Di = 18, L1 = 580			■	■			■			1319421A
	Di = 18, L1 = 1100, L2 = 17, H = 75 Da = 25, 180°			■	■			■			1322496A
	Molded hose										
	Di = 18, Da = 25, L = 110			■	■	■	■	■			1322493A
Di = 20, Da = 27, L = 70			■	■	■	■	■			1321031A	
	Molded hose										
	Di = 18, Da = 25, L = 2,200			■	■	■	■	■			1319455A
	Di = 18, Da = 25, L = 3,000			■	■	■	■	■			1320783A
	Di = 20, Da = 27, L = 2,200			■	■	■	■	■			1319268A
	Molded hose										
	Di = 20, Da = 29, L = 2,230, 360°, with increased wall thickness			■	■	■	■	■			1319631A
	Molded hose										
	Di = 18, Da = 25, r = 30, L1 = 95, L2 = 25, L3 = 20			■	■	■	■	■			1320758A
	Molded hose										
	Di = 18, Da = 25, L1 = 73, L2 = 58			■	■	■	■	■			1319419A
	Molded hose										
	D1i = 18, D1a = 25, D2i = 15, D2a = 22, L1 = 62, L2 = 32, 45°, with reduction			■	■	■	■	■	■		
	Molded hose										
	D1i = 20, D1a = 28, D2i = 20, D2a = 28, L1 = 110, L2 = 60, L3 = 65, 180°			■	■	■	■	■	■		

Water System

		Air Top 2000 STC	Air Top Evo 40/55	Thermo Top C/E	Thermo Pro 50 Eco	Thermo Top Evo	Thermo Pro 90	DBW 2010/2016	Thermo 230/300/350	Thermo S 230/300/350/400	Order number
	Molded hose										
	D1i = 15, D1a = 22, D2i = 18, D2a = 25, with reduction			■	■	■	■	■	■	■	1319402A
	Connecting pipe										
	D = 15, L = 75, brass			■	■	■	■	■	■	■	1319279A
	Connecting pipe										
	D1a = 17, D2a = 20, plastic, black			■	■	■	■	■	■	■	1320143A
	D1a = 18, D2a = 22, plastic, black			■	■	■	■	■	■	■	1320155A
	D1a = 20, D2a = 22, plastic, black			■	■	■	■	■	■	■	1319594A
	D1a = 20, D2a = 14, aluminium			■	■	■	■	■	■	■	1319722A
L = 63											
	T-piece										
	D1a = 15, D2a = 15, steel corrosion-resistant			■	■	■	■	■	■	■	1319289A
	D1a = 18, D2a = 15, steel corrosion-resistant			■	■	■	■	■	■	■	1320532A
	D1a = 18, D2a = 18, plastic, black			■	■	■	■	■	■	■	1321001A
	D1a = 20, D2a = 10, steel corrosion-resistant			■	■	■	■	■	■	■	1319846A
	D1a = 20, D2a = 15, steel corrosion-resistant			■	■	■	■	■	■	■	1319290A
D1a = 20, D2a = 20, brass			■	■	■	■	■	■	■	1319602A	
L = 75											
	T-piece										
	D1a = 20, D2a = 20, steel corrosion-resistant, with restrictor, restrictor diameter 5.8 mm			■	■	■	■	■	■	■	1319817A
	T-piece										
	Da = 18, L = 75, steel corrosion-resistant, with restrictor, restrictor diameter 4 mm			■	■	■	■	■	■	■	1319800A
	Connecting piece										
	Da = 18, L = 75, steel corrosion-resistant			■	■	■	■	■	■	■	1319266A
	Connecting pipe										
	Da = 38, L = 100, M22 x 1.5 thread connection, steel corrosion-resistant, for thermostat								■	■	1319286A



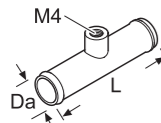
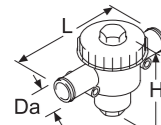
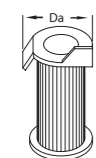
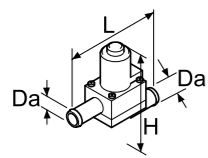
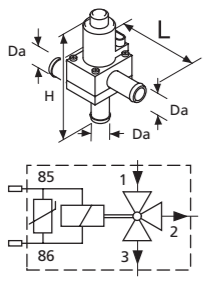
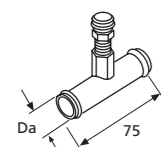
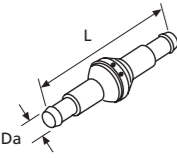

Water System

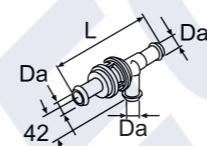
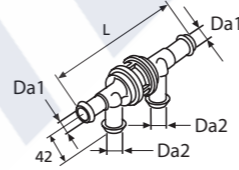
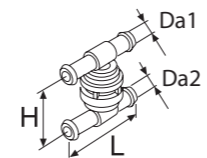
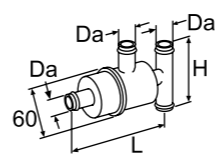
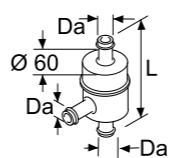
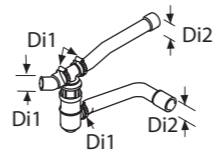
	Air Top 2000 STC	Air Top Evo 40/55	Thermo Top C/E	Thermo Pro 50 Eco	Thermo Top Evo	Thermo Pro 90	DBW 2010/2016	Thermo 230/300/350	Thermo S 230/300/350/400	Order number
 <p>Connecting pipe Da = 15 Da = 18 L = 65, M4 thread connection, steel corrosion-resistant, for thermostat</p>			■	■	■	■	■	■	■	1319263A
			■	■	■	■	■	■	■	1319519A
 <p>Shutoff valve Da = 38, L = 200, W = 85.5, H = 131, plastic PA66, operating pressure -0.5 to 4 bar, fluid temperature -30 to 110 °C, weight 0.5 kg, with filter</p>							■	■	1319931A	
 <p>Filter insert Da = 38, for shutoff valve with filter 1319931A</p>							■	■	1319710A	
 <p>Electric valve Da = 20, L = 106, H = 100, 12 V, metal / plastic, 2/2-way, normally open, operating temperature -40 to 85 °C</p>			■	■	■	■	■	■	1319981A	
 <p>Electric valve Da = 18, L = 84, W = 55, H = 101, 12 V, metal / plastic, plastic casing, 3/2-way, open without power, bag with electrical mounting parts</p>			■	■	■	■	■	■	9014606A	
 <p>Connecting pipe Da = 15 Da = 18 Da = 20 Steel corrosion-resistant, with bleeder valve</p>			■	■	■	■	■	■	1319221A	
			■	■	■	■	■	■	■	1319219A
			■	■	■	■	■	■	■	1320989A
 <p>Check valve Da = 15, L = 104 Da = 15, L = 104 Da = 18, L = 90 Da = 18, L = 100 Da = 20, L = 120 Plastic, black, without leak hole</p>			■	■	■	■	■	■	1320240A	
			■	■	■	■	■	■	■	1320239A
			■	■	■	■	■	■	■	1319250A
			■	■	■	■	■	■	■	1319484A
			■	■	■	■	■	■	■	1319554A

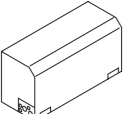

Water System

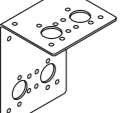
	Air Top 2000 STC	Air Top Evo 40/55	Thermo Top C/E	Thermo Pro 50 Eco	Thermo Top Evo	Thermo Pro 90	DBW 2010/2016	Thermo 230/300/350	Thermo S 230/300/350/400	Order number
 <p>Check valve Da = 18, L = 104, plastic, black, without leak hole</p>			■	■	■	■	■	■	■	1320563A
 <p>Check valve D1a = 18, D2a = 18, L = 146, plastic, black, with leak hole D1a = 20, D2a = 20, L = 162, brass, with leak hole D1a = 18, D2a = 18, L = 146, plastic, black, without leak hole H = 42</p>			■	■	■	■	■	■	■	1319486A
			■	■	■	■	■	■	■	1319595A
			■	■	■	■	■	■	■	1319485A
 <p>Check valve D1a = 18, D2a = 18, L = 82, H = 82, plastic, black, with bypass, without leak hole</p>			■	■	■	■	■	■	■	1319255A
 <p>Thermostatic valve Da = 18 Da = 20 L = 108, H = 70, brass / steel coated, with leak hole, starts to open at 59 °C</p>			■	■	■	■	■	■	■	1319986A
			■	■	■	■	■	■	■	1320253A
 <p>Thermostatic valve Da = 20, L = 112, brass / steel coated, without leak hole, starts to open at 70 °C</p>			■	■	■	■	■	■	■	1320033A
 <p>Combination valve Da = 18, brass / steel coated, with leak hole, starts to open at 40 °C</p>			■	■	■	■	■	■	■	1319650A

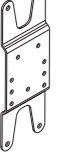
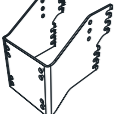
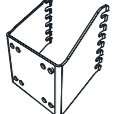
Mounting Parts

	Air Top 2000 STC	Air Top Evo 40/55	Thermo Top C/E	Thermo Pro 50 Eco	Thermo Top Evo	Thermo Pro 90	DBW 2010/2016	Thermo 230/300/350	Thermo S 230/300/350/400	Order number
	■	■								9005942B
Air Top Box										
Plastic/steel, for mounting Webasto air heaters on commercial vehicle bodies, with holder and mounting accessories										
	■									86032A
Installation box										
Steel, enables additional installation options, including heating air adapte										
	■		■							1311609B
Air Top Evo installation box										
Steel										9016392B
Steel										
With mounting parts and brackets										
	■	■								1319936A
Holder for air heaters										
Stainless steel, suitable for various installation options										
	■	■								1320995A
Air heater holding plate										
Stainless steel, for reinforcement on thin body panels										
	■	■								1321444A
Mounting base										
H = 35, D = 130, aluminium / steel, for air heaters, for mounting air heaters on the vehicle floor, overall height of 35 mm makes them suitable for very thick carpets / mats / insulation or other cladding, (without stud bolt)										
				■	■					1320500A
Thermo Top Evo holder										
Steel corrosion-resistant, standard holder										
				■	■					1320495A
Thermo Top Evo holder										
Steel corrosion-resistant, for horizontal installation										
				■	■					1320494A
Thermo Top Evo holder										
Steel corrosion-resistant, for vertical installation										

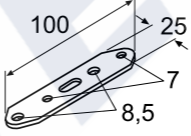
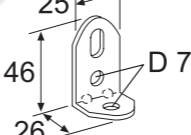
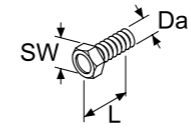
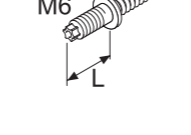
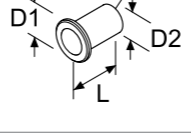
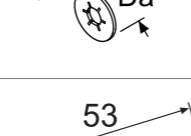
Mounting Parts

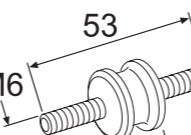
	Air Top 2000 STC	Air Top Evo 40/55	Thermo Top C/E	Thermo Pro 50 Eco	Thermo Top Evo	Thermo Pro 90	DBW 2010/2016	Thermo 230/300/350	Thermo S 230/300/350/400	Order number
					■	■				1322832A
Thermo Top Evo holding bracket kit										
For fastening water connection piece of Thermo Top Evo, with seals and screw										
	■	■	■	■	■	■	■	■	■	9007918A
Mounting strip										
Steel zinc coated, 10 pieces										1319818A
Stainless steel										
L = 100, W = 25										
	■	■	■	■	■	■	■	■	■	1320232A
Mounting bracket										
Steel zinc coated										1320264A
Stainless steel										
L = 46, W = 25, D = 26, 10 pieces										
			■	■						9011669A
self-tapping screw										
Da = 6, L = 22, SW = 10, steel zinc coated, bag of 10 pieces										
			■	■						9006446A
Self-tapping stud bolt										
L = 16										9009025A
L = 31										
M6, steel zinc coated, bag of 10 pieces										
	■	■	■	■	■	■	■	■	■	9011635A
Rivet-in nut										
D1a = 13, D2a = 9, D1 = 13, D2 = 9, L = 15, M6 x 15.5, aluminium, bag of 10 pieces										
	■	■	■	■	■	■	■	■	■	9011659A
Pin lock										
Da = 12.5, L = 0, M6, steel corrosion-resistant, bag of 10 pieces										
	■	■	■	■	■	■				1320270A
Anti-vibration mount										
L = 53, M6 thread, not suitable for fastening heaters, 5 pieces										

Mounting Parts

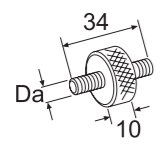
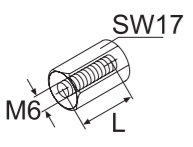
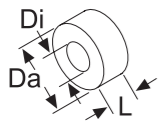
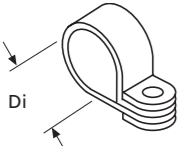
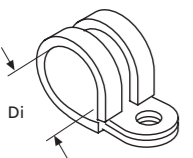
	Air Top 2000 STC	Air Top Evo 40/55	Thermo Top C/E	Thermo Pro 50 Eco	Thermo Top Evo	Thermo Pro 90	DBW 2010/2016	Thermo 230/300/350	Thermo S 230/300/350/400	Order number	
	Anti-vibration mount										
	Da = M6 thread										9023020A
	Da = M8 thread										1319553A
	L = 34, not suitable for fastening heaters, 5 pieces										
	Spacer nut										
	L = 15										1320256A
	L = 20										1320241A
	L = 30										1320083A
	L = 40										1319517A
SW = 17, Full-length M6 thread, steel corrosion-resistant											
	Spacer bushing										
	Di = 7, Da = 18, L = 8										1320091A
	Di = 8, Da = 20, L = 5										1320498A
	Di = 8, Da = 20, L = 8										1320499A
	Di = 8, Da = 20, L = 10										1320496A
	Di = 8, Da = 20, L = 15										1320090A
	Di = 8, Da = 20, L = 20										1320088A
	Di = 8, Da = 20, L = 30										1320089A
	Di = 8, Da = 20, L = 40										1319533A
	Di = 9, Da = 25, L = 14										1320092A
Aluminium											
	Pipe clip										
	Di = 18, W = 15, steel zinc coated, 6.5 mm fastening hole										1320042A
	Di = 25, W = 15, stainless steel, 6.5 mm fastening hole, bag of 10 pieces										9023007A
	Di = 28, W = 15, steel zinc coated, 6.5 mm fastening hole, 5 pieces										1320277A
	Di = 33, W = 15, W = 15, stainless steel, 6.5 mm fastening hole										1320064A
	Di = 42, W = 12, W = 12, stainless steel, 5.2 mm fastening hole										1319693A
	Di = 42, W = 15, W = 15, stainless steel, 6.5 mm fastening hole, 5 pieces										1320276A
	Di = 52, W = 15, W = 15, steel zinc coated, 6.5 mm fastening hole, 5 pieces										1320265A
	Pipe clip										
	Di = 5, W = 12, stainless steel / rubber, rubber-coated pipe clip, 5.2 mm fastening hole										1320195A
	Di = 29, W = 15, steel zinc coated / rubber, rubber-coated pipe clip, fastening hole 6.4 mm, 5 pieces										1320235A
	Di = 34, W = 15, steel zinc coated / rubber, rubber-coated pipe clip, fastening hole 6.4 mm										1319701A
	Di = 34, W = 20, steel zinc coated / rubber, 8.4 mm fastening hole, 10 pieces										1320236A
	Di = 35, W = 20, steel zinc coated / rubber, rubber-coated pipe clip, 8.4 mm fastening hole, bag with 5 pieces										9022835A

Mounting Parts

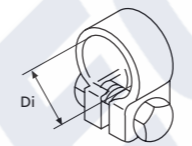
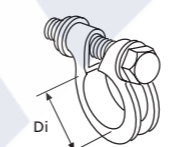
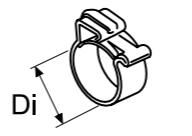
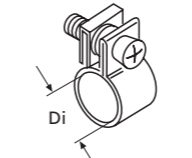
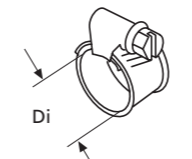
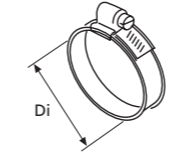
	Air Top 2000 STC	Air Top Evo 40/55	Thermo Top C/E	Thermo Pro 50 Eco	Thermo Top Evo	Thermo Pro 90	DBW 2010/2016	Thermo 230/300/350	Thermo S 230/300/350/400	Order number	
	Pipe clamp										
	Di = 24 ... 26, with carriage bolt										1320165A
	Di = 26 ... 28, nut, welded										1320220A
	W = 16, M6 thread, stainless steel, for flexible exhaust pipe										
	Pipe clamp										
	Di = 39 ... 42, W = 13.5, with screw										1320194A
	Di = 24 ... 27, W = 10.4, with screw										1320815A
	Di = 30, Da = 33, with carriage bolt M8 thread, steel corrosion-resistant, for flexible exhaust pipe										1320203A
	Cailleau hose clip										
	Di = 9.5 ... 11										9011661A
	Di = 10.5 ... 11.5										9011656A
W = 6, stainless steel, mounting with special tool, 10 pieces											
	Hose clip										
	Di = 8, steel corrosion-resistant, 20 pieces										1320244A
	Di = 9, steel corrosion-resistant										1320492A
	Di = 10, steel corrosion-resistant, 50 pieces										9023037A
	Di = 12, steel corrosion-resistant, 20 pieces										1320246A
	Di = 14, steel corrosion-resistant, 20 pieces										1320245A
	Di = 14, stainless steel, 10 pieces										1320249A
W = 9, SW = 7, bolt head with hexagon and cross-head slot											
	Hose clip										
	Di = 16 ... 25, steel corrosion-resistant, 20 pieces										1320248A
	Di = 16 ... 27, stainless steel, 10 pieces										9015918A
	Di = 23 ... 35, stainless steel, 20 pieces										1320271A
	Di = 32 ... 50, steel corrosion-resistant, 10 pieces										1321064A
W = 9, SW = 7, bolt head with hexagon and cross-head slot											
	Hose clip										
	Di = 40 ... 47, W = 14.3, SW = 8, steel corrosion-resistant										1320158A
	Di = 48 ... 55, W = 14.3, SW = 8, steel corrosion-resistant										1320159A
	Di = 70 ... 90, W = 14.3, SW = 8, steel corrosion-resistant										1320223A
	Di = 72 ... 79, W = 14.3, SW = 8, steel corrosion-resistant										1320160A
	Di = 80 ... 87, W = 14.3, SW = 8, steel corrosion-resistant										1320162A
	Di = 78 ... 102, W = 12.7, SW = 7, stainless steel										1320817A
Di = 98 ... 120, W = 14.3, SW = 8, steel corrosion-resistant Bolt head with hexagon and slot										1320161A	



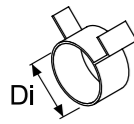
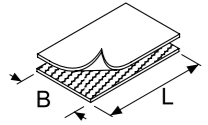
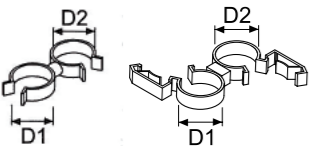
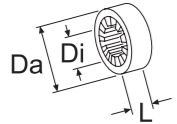
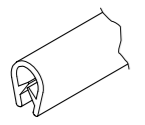
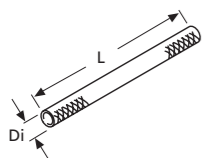
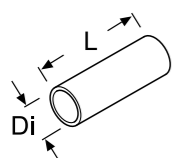

Mounting Parts

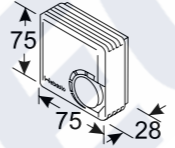
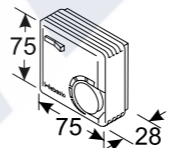
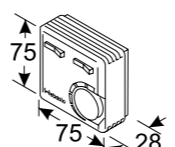
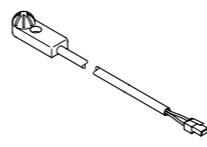
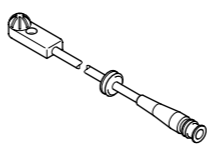
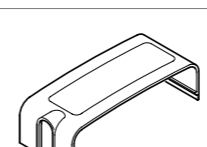
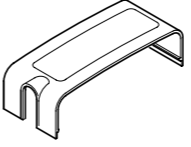
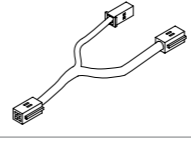
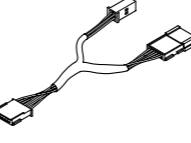
	Air Top 2000 STC	Air Top Evo 40/55	Thermo Top C/E	Thermo Pro 50 Eco	Thermo Top Evo	Thermo Pro 90	DBW 2010/2016	Thermo 230/300/350	Thermo S 230/300/350/400	Order number	
	Spring clip										
	Di = 25, light grey										9009019A
	Di = 27, dark grey										9009018A
	Di = 22, black, space-saving clip, E2										9011662A
	Di = 25, black, space-saving clip, E2										9009022A
	Di = 27, black, space-saving clip, E2										9009023A
Di = 28, black, with stopping component, E1										9014607A	
W = 12, steel corrosion-resistant, bag of 10 pieces											
	Dual lock velcro strip										
	L = 50										1320202A
	L = 100										1320708A
W = 25, plastic, black, self-adhesive											
	Hose and cable holder										
	D1 = 10 – 12, D2 = 19 – 24.5										9010999A
	D1 = 27, D2 = 27, locking										9010997A
	D1 = 22 – 24, D2 = 22 – 24										9011000A
	D1 = 25 – 28, D2 = 21.5 – 24										9011001A
D1 = 37 – 41, D2 = 21.5 – 24										9011002A	
Plastic, black, bag of 5 pieces											
	Rubber ring (anti-chafing device)										
	Di = 13.5, Da = 31, L = 15, elastomer, black, 10 pieces										1321063A
	Di = 20.5, Da = 40, L = 20, elastomer, black										1312785A
Di = 25.5, Da = 45, L = 20, EPDM-50, red										1312780A	
Not permitted for exhaust systems											
	Edge protector										
	L = 500										1319778A
L = 700										1320093A	
With wire coil, sheet thickness 1 to 4 mm											
	Braided protection hose										
	L = 1,500, chafing guard for polyester water hoses										1301317B
	L = 2,000, chafing guard for polyester water hoses										1322513A
	L = 5,000										1321596B
	L = 25,000										1321597B
Di = 26 ... 30, polyester											
	Heat shrinkable hose										
	L = 100										1322452A
	L = 5,000										1321590A
	L = 50,000										1321589A
Di = 38 ... 19, wall thickness 1 mm, shrinkage rate 2:1, operating temperature range -55 °C to +125 °C											

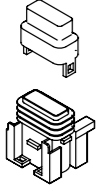

Electrical Accessories

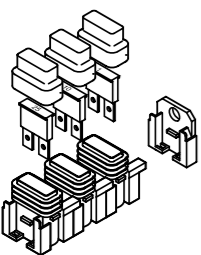
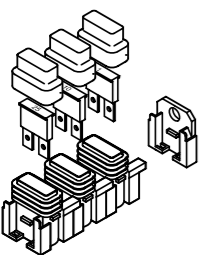
	Air Top 2000 STC	Air Top Evo 40/55	Thermo Top C/E	Thermo Pro 50 Eco	Thermo Top Evo	Thermo Pro 90	DBW 2010/2016	Thermo 230/300/350	Thermo S 230/300/350/400	Dual Top Evo	Order number	
	Compartment thermostat											
	L = 75, W = 28, H = 75, plastic, black, for vehicle blower, mechanical (changeover contact)											1320587A
	Compartment thermostat											
	L = 75, W = 28, H = 75, plastic, black, for vehicle blower, mechanical (changeover contact), with on/off switch											1320415A
	Compartment thermostat											
	L = 75, W = 28, H = 75, plastic, black, mechanical (changeover contact) with on/off switch and ventilation											1320416A
	Temperature sensor external											
	Wiring harness length 5 m											1319842A
	Temperature sensor external											
	Wiring harness length 5 m, with housing cover											93205A
	Wiring harness length 20 m, with housing cover											92649B
	Temperature sensor external											
	Bag external Temperature Sensor Air Top 5 m											9030883A
Bag external Temperature Sensor Air Top 2.5 m											9030881A	
	Housing cover											
	As replacement when using external temperature sensor, with grommet, with grommet											1319621A
	Y adapter for wiring harness											
	For retrofitting ThermoCall with Telestart already fitted											1319820A
	Y adapter for wiring harness											
	Telestart digital timer 1533 connection											1319873A

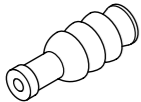
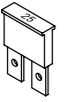

Electrical Accessories

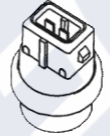
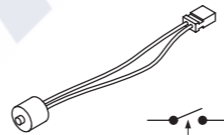
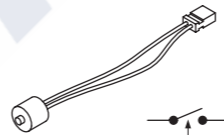
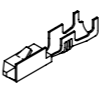
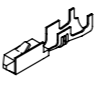
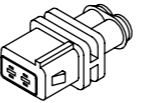
	Air Top 2000 5TC	Air Top Evo 40/55	Thermo Top C/E	Thermo Pro 50 Eco	Thermo Top Evo	Thermo Pro 90	DBW 2010/2016	Thermo 230/300/350	Thermo S 230/300/350/400	Dual Top Evo	Order number	
	Fuse holder											
	1 A, for 1 A blade fuse, for 6.3 mm tab connector, with slot marking in black											1320313A
	5 A, for 5 A blade seal, for 6.3 mm tab connector, with slot marking in beige											1320157A
	20 A, for 20 A blade fuse, for 6.3 mm tab connector, with slot marking in yellow 6.3 mm, plastic, black, SAE J1284, watertight											1320151A
	Mounting base											
	Plastic, black, for fuse holders, 1320313A, 1320157A, 1320151A, with screws											1320873A
	Additional fuse kit											
	6.3 mm, plastic, black, for flat fuses SAE J1284, watertight, contents: 1 fuse holder 1320313A with all connection accessories and single-wire seals (without fuses and mounting base)											1301682A
	Fuse holder kit											
	Plastic, black, watertight, replaces triple fuse holder on heater wiring harness, contents: 3 1320313A fuse holders and mounting parts (without fuses and mounting bases)											1321809A
	Flat spring contact											
	0.5 ... 1.5											9011645A
	2.0 ... 3.0											9011647A
	4.0 ... 6.0											9009029B
For fuse holder, watertight, bag of 10 pieces												
	Single-wire seal											
	Da = 5.4, 0.35 ... 1.00, L = 8, light blue											9011626A
	Da = 4.1, 0.5 ... 0.75, L = 9, green											9011955A
	Da = 5.4, 1.5 ... 2.5, L = 8, white, 10 pieces											9011627A
	Da = 5.6, L = 8, red, for MTA-fuse holder											9011631A
Bag of 20 pieces												
	Blade fuse											
	15 A, light blue											9023139A
	20 A, brown											9023141A
	25 A, white											9023142A
6.3 mm, bag of 20 pieces												

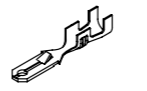
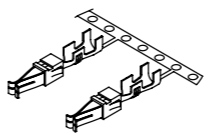
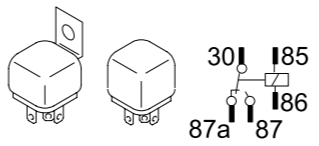



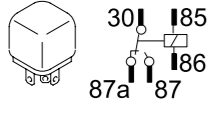
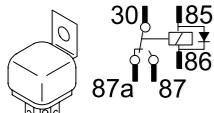
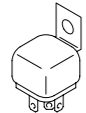
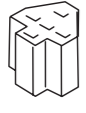
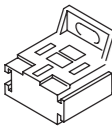
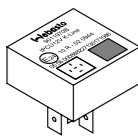
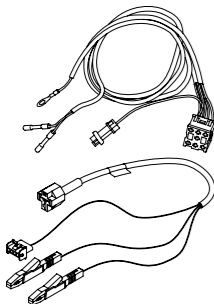









Electrical Accessories

	Air Top 2000 5TC	Air Top Evo 40/55	Thermo Top C/E	Thermo Pro 50 Eco	Thermo Top Evo	Thermo Pro 90	DBW 2010/2016	Thermo 230/300/350	Thermo S 230/300/350/400	Dual Top Evo	Order number	
	Temperature switch											
	Closes at 2 °C for operating the parking heater as an auxiliary heater											1319804A
	Closes at 10 °C, for operating the parking heater as an auxiliary heater											1321617A
	Closes at 12 °C, for operating the parking heater as an auxiliary heater											9030618A
	Holder											
	For temperature switch, for mounting the temperature switch on the vehicle											1319805A
	Temperature sensor											
	M4 fastening thread, closes at 40 °C											1322511A
	Flat spring contact											
	1.5 ... 2.5, 2.8 mm, with seals and plugs, bag of 10 pieces											9011664A
	Micro Quadlok System socket contact											
	0.75, 2.8 mm, for 6-pin watertight plug sleeve casing, bag of 10 pieces											9011666A
	Tab connector housing											
	1, 0.5 mm, 2-pin, watertight, bag of 5 pieces											9011632B
	Plug sleeve casing											
	E.g. for fuel pump or extensions, watertight, bag of 5 pieces											9021277A
	Tab connector											
	1 ... 2.5, 0.5 mm, for watertight plug connections, with seals and plugs, bag of 2 pieces											9011628A
	Junior power timer											
	1 ... 1, 0.5 mm, also for blade-type plug, watertight, bag of 10 pieces											9011634B
	Relay (changeover contact) kit											
	12 V, 30 / 50 A, plastic case, black, with connector housing and flat fuses, contains 1 relay base and 1 tab receptacle											9023375A



Electrical Accessories

	Air Top 2000 STC	Air Top Evo 40/55	Thermo Top C/E	Thermo Pro 50 Eco	Thermo Top Evo	Thermo Pro 90	DBW 2010/2016	Thermo 230/300/350	Thermo S 230/300/350/400	Dual Top Evo	Order number
 Relay (changeover contact) 12 V, 30 / 50 A, plastic case, plastic housing, black, protection class IP67, without mounting tab											1320947A
 Relay (changeover contact) 12 V, plastic case, grey, with included mounting tab, freewheeling diode											1319954A
 Relay (changeover contact) with freewheeling diode 24 V, protection class IP67, with mounting tab for M5 screw											1320214A
 Relay base For standard relay, without mounting tab											1320538A
 Relay base For standard relay, with mounting tab											1320540A
 IPCU module 12 V, plastic case, black, for PWM of vehicle blowers			■	■							1322640A
 IPCU kit 12 V, plastic case, black, for PWM of vehicle blowers, with IPCU module, wiring harnesses and installation instructions			■	■							9013645A
 Plug sleeve casing For 6.3 mm receptacles, 1-pin, 20 pieces											1320229A
 Tab connector housing For 6.3 mm tab connector, 1-pin, 20 pieces											9006460A

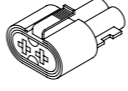
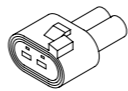
Electrical Accessories

	Air Top 2000 STC	Air Top Evo 40/55	Thermo Top C/E	Thermo Pro 50 Eco	Thermo Top Evo	Thermo Pro 90	DBW 2010/2016	Thermo 230/300/350	Thermo S 230/300/350/400	Dual Top Evo	Order number
 Plug sleeve casing For 6.3 mm tab receptacles, 2-pin, 1 piece											1319698A
 Tab connector housing For 6.3 mm tab connector, 2-pin, 20 pieces											1320230A
 Plug sleeve casing For 6.3 mm tab receptacles, 4-pin, 10 pieces											1321698A
 Tab connector housing For 6.3 mm tab connector, 4-pin, 1 piece											1319699A
 Plug sleeve casing For 6.3 mm tab receptacles, 6-pin, 10 pieces											1321670A
 Tab connector housing For 6.3 mm tab connector, 6-pin, 20 pieces											1320231A
 Tab connector housing For 6.3 mm tab connector, 8-pin, 10 pieces											1321669A
 Tab receptacle For cable cross section 0.5 - 1.0 mm ²											9011636A
 Tab receptacle For cable cross section 1.0 mm ²											9011652A
 Tab receptacle For cable cross section 2.5 mm ²											9011641A
 Tab receptacle 6.3 mm, bag of 10 pieces											
 Tab receptacle 6.3 mm, for cable cross section 2.5 mm ² , 50 pieces											1320228A
 Tab receptacle For cable cross section 4.0 - 6.0 mm ²											9014955A
 Tab receptacle For cable cross section 0.8 - 2.5 mm ²											9011640A
 Tab receptacle 6.3 mm, bag of 10 pieces											
 Repair kit for Thermo Top C wiring harness With 2-pin an 6-pin socket housings, flat spring contacts and single-wire seals			■	■							9011968A
 Tab connector housing For standard wiring harness, 2-pin, watertight, with flat spring contacts and single-wire seals			■								9021719A

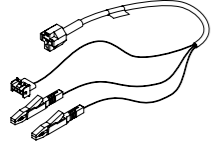
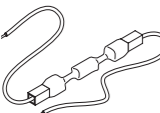
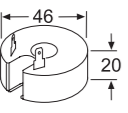
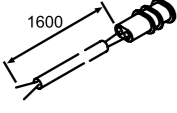
Electrical Accessories

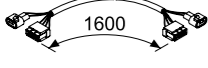
	Air Top 2000 5TC	Air Top Evo 40/55	Thermo Top C/E	Thermo Pro 50 Eco	Thermo Top Evo	Thermo Pro 90	DBW 2010/2016	Thermo 230/300/350	Thermo S 230/300/350/400	Dual Top Evo	Order number
	Programming wiring harness										
Wiring harness for programming with PC diagnostic kit			■	■	■	■					1319879B
	Blocking diode										
3 A, with connection cables											1320826A
	Resistor kit										
W = 46, H = 20, 40 W, 0.9 Ω, with plugs and fastening parts											97981A
	Adapter wiring harness										
For Thermo Top C coolant pump			■								1320279A
	Thermo Top C dummy plug										
If coolant pump is omitted, with resistor			■								1319667A
	Thermo Top C wiring harness extension										
Extension for standard wiring harness			■	■							1319720A
Plug kit											
For fuel pump 42, replacement for 2-pin plug on the fuel pump wiring harness, with connection materials and assembly instructions			■	■	■	■					1318966A
Kit for Thermo Pro 50 Eco plug											
Replacement for 10-pin plug on standard wiring harness, with connection materials				■							9029701A
Replacement for 2-pin plug on the standard wiring harness, with connection materials				■							9029702A
Replacement for 4-pin plug on standard wiring harness, with connection materials				■							9029703A
Thermo Top Evo plug kit											
Replacement for 2- and 6-pin plugs on standard wiring harness, with connection materials					■						1319023A
Extension cable control panel Air Top Standard/MC											
L = 1,800			■								1319724A
Kit Dual Top wiring harness old to new											
										■	1320837A

Test Equipment

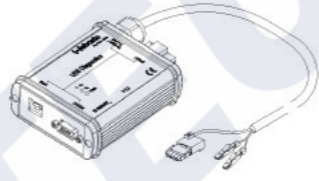
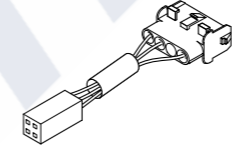
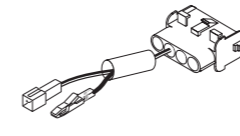
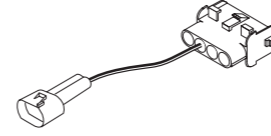
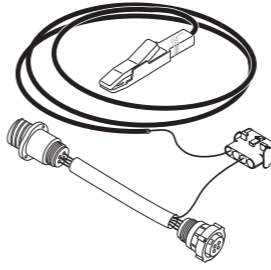
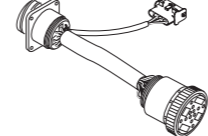
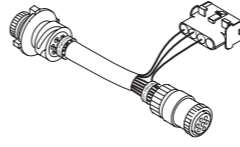
	Air Top 2000 5TC	Air Top Evo 40/55	Thermo Top C/E	Thermo Pro 50 Eco	Thermo Top Evo	Thermo Pro 90	DBW 2010/2016	Thermo 230/300/350	Thermo S 230/300/350/400	Order number
	PC Diagnosis Kit									
For Windows operating system, USB and serial port	■	■	■	■	■	■	■	■	■	1320920A
	Adapter cable, PC diagnosis									
Also for upgrade kit (digital timer 1533 or Telestart)	■	■	■	■	■	■				1319503A
	Adapter cable, PC diagnosis									
			■							1319943A
	Adapter cable, PC diagnosis									
	■									1319940A
	Adapter cable, PC diagnosis									
								■		1320899A
	Adapter cable, PC diagnosis									
Thermo 230/300/350 (Van Hool)								■		1319945A
	Adapter cable, PC diagnosis									
Thermo 230/300/350 (Mercedes / Citaro)								■		1319685A

Special tools

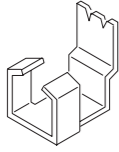
	Air Top 2000 STC	Air Top Evo 40/55	Thermo Top C/E	Thermo Pro 50 Eco	Thermo Top Evo	Thermo Pro 90	DBW 2010/2016	Thermo 230/300/350	Thermo S 230/300/350/400	Order number	
	Adjusting tool										
	For ignition electrodes									1320998A	
Locking compound											
20 ml, red, for nuts and bolts											1320535A

Webasto subsidiaries and representatives

Head Office

Webasto Thermo & Comfort SE

Friedrichshafener Straße 9
82205 Gilching
Tel.: +49 89 85794-0
www.webasto.com

Bulgaria

Rhea MP GmbH

ul. Boris Iliev 17
1839 Sofia
Tel.: +359 2 9420555
www.rheamp.com

Estonia

AS KG KNUTSSON

Saeveski 12
11214 Tallinn
Tel.: +372 6 519300
www.kgk.ee

Argentina

Friba Tecnologia S.A.

Av. Pavón 4080/84
C1253AAY Buenos Aires
Tel.: (54-11) 4924-2117
www.friba.com.ar

Chile

Webasto Thermo & Comfort - LATAM

Hermanos Cabot 6707 - Dpt. 126
Las Condes – Santiago de Chile
7561255 – Chile
+34 91 626 8618 (HQ)
www.webasto.es

Finland

Oy Kaha AB

Ansatie 2
1740 Vantaa
Tel.: +358 9 61568379
www.kaha.fi

Australia

Webasto Thermo & Comfort

Australia Pty. Ltd.
423-427 The Boulevard
NSW 2232 Kirrawee
Tel.: +61 2 85364800
www.webasto.com.au

Carlos Becker y Cia. Ltda.

Avda. Luis Thayer Ojeda 166, Of. 907
7510017 Providencia Santiago de Chile
Tel.: +56 2 2344311
www.beckercia.cl

France

Webasto Thermo & Comfort

France S.A.S.
PA Estuaire Sud
Rue du Camp d'Aviation
44320 Saint Viaud
Tel.: +33 (0)2.40.21.85.50
www.webasto-france.fr

Belarus

Falkat GmbH

Ul. Drozda 8
220004 Minsk
Tel.: +375 17 2001894
www.falkat.com

China

Webasto Thermo & Comfort

Beijing Co. Ltd.

A 2103. Tower 2. Boya International
1 Lize Zhongyi Road
Chaoyang District
100102 Beijing
Tel.: +86 10 84782320
www.parkingheater.cn

Greece –

via Webasto Head Office
Webasto Thermo & Comfort SE
Friedrichshafener Straße 9
82205 Gilching
Tel.: +49 89 85794-0
www.webasto.com

Benelux

Webasto Thermo & Comfort

Benelux B.V.
Constructieweg 47
8263 BC Kampen
Tel.: +31 38 3371137
www.webasto.nl

Denmark

Webasto Thermo & Comfort

Denmark A/S
Islevdalvej 180
2610 Rødovre/Copenhagen
Tel.: +45 44522000
www.webasto.dk

Great Britain

Webasto Thermo & Comfort UK Ltd.

Webasto House
White Rose Way
Doncaster
South Yorkshire DN4 5JH
Tel.: +44 (0) 1302 322232
www.webasto.co.uk

Brasil

Webasto Thermo & Comfort – LATAM

Av. Padre Manoel da Nóbrega,
355 – A31 – Campinas – SP
13061 – 140 – Brasil
Tel.: +55 19 9 9504 5151
www.webasto.com/br

Germany

Webasto Thermo & Comfort SE

Postfach 1410
82199 Gilching
Tel.: +49 (0) 395 5592-229
www.webasto.de

India

Webasto Roofsystems India Ltd.

Ghat 838/1, Pune Nagar Road
District: Sanaswadi
412208 Pune
www.webasto.com

Webasto subsidiaries and representatives

Iceland

Bilasmidurinn hf.
Bildshofda 16
110 Reykjavik
Tel.: +354 5657233
www.bilasmidurinn.is

Italy

Webasto Thermo & Comfort Italy S.r.L.
Via Efrem Nobili 2
CAP 40062 Molinella (BO)
Tel.: +39 051 6906 111
www.webasto.it

Japan

Webasto Thermo & Comfort Japan Co., Ltd.
3-19-5 Shin-Yokohama Kohoku-ku
Yokohama, Kanagawa Prefecture
222-0033 Japan
Tel.: +81 45 4741761
www.webasto.co.jp

Kazakhstan – via Webasto Russia

Webasto Rus OOO
Altajskaja ul. 19, 1/a
107065 Moscow
Tel.: +74 95 7770245
www.webasto.ru

Latvia

SIA KG Knutsson
K. Ulmana gatve 2
1004 Riga
Tel.: +371 780 7873

Lithuania

UAB KG Knutsson
Jocioniu g 14
Vilnius. LT - 02300
Tel.: +370 2758181
www.kgk.lt

Moldavia – via Webasto Romania

Webasto Romania Trading S.R.L.
Sos Odai, nr.40
075100 Otopeni, Ilfov
Tel.: +40 21 2032751
www.webasto.ro

Mongolia

MSM Group LLC
MSM Building, Chinggis avenue – 62
Industry Zone 17070
3rd Khoroo
Khan-Uul District
CPO Box 154 Ulaanbaatar
Tel. +976 7014 8138

Netherlands

Webasto Thermo & Comfort Benelux B.V.
Constructieweg 47
8263 BC Kampen
Tel.: +31 38 3371137
www.webasto.nl

Norway

Webasto Thermo & Comfort Norwegen
Industriveien 34A
2072 Dal
Tel.: +47 61162000
www.webasto.no

Austria

Webasto Fahrzeugtechnik G.m.b.H.
Jochen-Rindt-Straße 19
1230 Vienna
Tel.: +43 (1) 6043780
www.webasto.at

Poland

Webasto Petemar Sp. z.o.o.
ul. Warszawska 205/219
05-092 Lomianki
Tel.: +48 22 7327320
www.webasto.pl

Romania

Webasto Romania Trading S.R.L.
Sos Odai, nr.40
075100 Otopeni, Ilfov
Tel.: +40 21 2032751
www.webasto.ro

Russia

Webasto Rus OOO
Altajskaja ul. 19, 1/a
107065 Moscow
Tel.: +74 95 7770245
www.webasto.ru

Sweden

KG Knutsson AB
Hammarbacken 8
19181 Sollentuna. Stockholm
Tel.: +46 8 923000
www.kgk.se

Switzerland

Webasto Thermo & Comfort Schweiz AG
Hagmattstrasse 4
CH 4123 Allschwil
Tel.: +41 61 4869580
www.webasto.ch

Slovakia

Webasto Thermo & Comfort Slovakia s.r.o.
Galgovecká ulica 3
Rozvojova 3 SK - 040 11 Košice
Tel.: +421 5 57871000
www.webasto.sk

Webasto subsidiaries and representatives

Slovenia

Webasto Thermo & Comfort avtomobilaska tehnika d.o.o.
Cesta v Gorice 34
1000 Ljubljana
Tel.: +386 1 2008712
www.webasto.si

Spain

Webasto Thermo & Comfort Ibérica S.L.U.
C/Mar Tirreno 33
Polígono Industrial
28830 San Fernando de Henares (Madrid)
Tel.: +34 91 626 86 11
www.webasto.es

South Korea

Webasto Korea Inc.
40 Imi-ro, Bldg. B, Suite 612
16006 Uiwang-si, Gyeonggi-do
Tel.: +82 31 80170241

Czech Republic

Webasto Thermo & Comfort Czech Republic s.r.o.
Na Strži 1373
Praha 4
Tel.: +420 241045450-7
www.webasto.cz

Turkey

Webasto Thermo Comfort İklimlendirme Sistemleri Ltd. Sti,
Manisa Organize Sanayi Boelgesi 4. Kısım
Ahmet Nazif Zorlu Bulvarı No: 8
45030 Merkez/Manisa
Tel.: +90 236 226 90 00
www.webasto.com.tr

Ukraine

Webasto Thermo & Comfort Ukraina Tz
Chervonopraporna str. 28
03045 Kiev
Tel.: +380 (044) 503-31-76
www.webasto.com/ua

Hungary

Webasto Thermo & Comfort Hungária Kft.
Szent László út 73
1135 Budapest
Tel.: +36 1 3502338
www.webasto.hu

USA

Webasto Thermo & Comfort North America Inc.
15083 North Road
48430 Fenton. Michigan
Tel.: +1 810 5936100
www.webasto.us



For more than 75 years, the Webasto group has continued to set new technological standards – in both the original equipment sector and the aftermarket. As one of the 100 biggest suppliers in the automotive industry worldwide, we develop and produce roof, convertible as well as heating, cooling and ventilation systems. Our products help provide a better atmosphere on the road, more comfort and security, as well as increased efficiency for cars, commercial and special vehicles, motor homes and boats. An outstanding network of production facilities and dealers guarantees high-quality products, installation standards and services worldwide.